



MX-4071/3571/3071
MX-4061/3561/3061

A3 Colour MFPs

www.sharp.co.uk

SHARP
Be Original.

All you need to do more.

Getting things done fast shouldn't mean compromising on quality. These next generation MFPs give you the best of both worlds.



The powerful performance and intuitive control of Sharp's enterprise devices have been recognised with the prestigious Buyers Lab PaceSetter award. Our A3 colour Multifunction Printers (MFPs) build on these capabilities with their enhanced feature set and superior functionality.

They act as a secure information hub within small & medium businesses (SMBs) or medium size workgroups in large organisations. As well as including a range of advanced tools to help you work more flexibly and productively they also provide a simple way to create, use and share all of the information you need.

So, whatever you're doing, whether it's producing meeting materials, printing reports, scanning documents or sending key information by email, and wherever you're working, you can do it all with outstanding speed and simplicity.

Designed to perform.

MFPs help you to achieve much more without working harder.

Fast printing

They also include a Reversing Single Pass Feeder (RSPF)*¹ or a Duplex Single Pass Feeder (DSPF) with a flashing LED*² that notifies you if any original documents are left behind, helping you to keep documents secure and GDPR compliant.



Flashing light reminds users to remove original documents.

Easy to use

A tiltable, large 10.1" LCD touchscreen control panel provides easy access to commonly used functions via Easy Mode. Alternatively the screen can customise it simply by dragging and dropping menu icons.



Tilt the panel to suit your requirements.

Efficient storage

A large 500GB onboard Hard Disk Drive (HDD) and a Document Filing feature enable fast and hassle-free printing and scanning.

Consistent quality

Text and graphics on documents from any application are accurately reproduced using Adobe PostScript 3 and an image density sensor maintains a consistent image quality from first page to the last. The Auto Set function also adjusts the scanning settings to optimise the resolution, page size and orientation.

Optimised direct PDF printing

Adobe Embedded Printer Engine (AEPE) enhances printing for the technology driven workplace, delivering up to 80% faster printing from mobile, cloud and USB.

Less waiting

A built-in Motion Sensor avoids any delays by detecting an approaching user and instantly wakes the MFP from sleep mode.

Extra savings

The toner cartridge automatically ejects only when the toner has been fully exhausted, saving toner, minimising waste and supporting environmental goals.

Simple management

Check the status of the MFP with just a quick glance at the lights of the Status Communication Bar.



Distinct light patterns indicate specific MFP functions.

*¹ MX-4061/MX-3561/MX-3061 only. *² MX-4071/MX-3571/MX-3071 only.

Keeping you safe.

Information is the life-blood of any organisation. That's why the most stringent protection is included as standard.

Always on guard

Enjoy non-stop peace of mind with an innovative Self-Healing System. A master copy of the MFP settings is backed up in a different part of the system. It can be automatically validated before being recovered if the operational system is accidentally or maliciously corrupted. It also avoids any disruption to your business and ensures that valuable information and intellectual property is robustly protected.

Security you can trust

When information is exchanged between an MFP and another application or email system it can be intercepted or compromised. These MFPs include SSL Certificate Validation, which checks all incoming and outgoing communication attempts to prevent any unauthorised or malicious access to your information. This high level of security is often a requirement of government organisations.

Proactive access control

To prevent any unauthorised use, these MFPs automatically monitor access attempts and only grant access to applications and operating firmware that are on an approved whitelist. Any other external applications are instantly blocked, logged and reported.

Military-grade protection

These MFPs conform to the Protection Profile for Hardcopy Devices (HCD-PP v1.0), which is the most up-to-date security validation for business, government and military organisations. So you can confidently handle the most sensitive data knowing that your MFP is incredibly secure.

Safer email communication

Any documents you email directly from the MFP are encrypted using the S/MIME standard. It ensures they can't be intercepted during transmission and are validated as authentic using advanced electronic signatures.





Work your own way.

Being able to work flexibly, at anytime and anywhere, is key to squeezing the maximum value out of every day.

With these next generation MFPs you don't need to waste time fiddling around with complex technology. Their effortless connectivity means you can print, copy, scan and share the information you need quickly and efficiently wherever you're working.

Connections made easy

What could be easier than walking up to your MFP and printing whatever you want without even logging into your PC? With Sharp's Office Direct Print that's exactly what you get. Simply insert a USB memory stick in the MFP and immediately access and print images and Microsoft Office files. You can also scan and save documents straight to the USB stick.



Insert your USB stick and start printing.

For even greater flexibility, any WiFi enabled laptop, tablet or smartphone can directly connect to the MFP without the need to set up a wireless LAN. It allows you to print from a much broader range of devices and in a wider variety of business environments.

And if you operate separate networks in the same workplace, which might have different security or usage restrictions, everyone can still share the same Sharp MFP. These MFPs support dual LANs that can be connected to two different networks, one of which could be wireless*1.

One simple sign on

There's no need to remember additional usernames and passwords. Instead, you can quickly access public cloud services using Single Sign On (SSO). It lets you securely print and store information using Google Drive™, OneDrive® for Business, SharePoint® Online, Box, Dropbox and Cloud Portal Office with just one log in from the control panel. There's also a Gmail connector for scanning to email and Exchange Online (MS 365 email).

Print where you like

Worried about leaving important or sensitive documents out in the open? Not with the Print Release feature. Simply send a job to print and then, whenever you are ready, just walk over to the most convenient printer, log on and print off your information*2.



Release print jobs from the most convenient MFP.

*1 A USB to LAN connector is required for the secondary connection.

*2 Can be used from any of five network-connected MFPs.

Made for mobility

You'll love how fast and hassle-free printing from a mobile device is. You can link to the MFP in seconds by simply holding it over the NFC card reader*¹ or by scanning the MFP's QR code*². Either way, it configures everything for you.

You can then print from and scan to mobiles and tablets over your wireless network using Sharpdesk Mobile or print from any app that supports Google Cloud Print™ or any Android device with the Sharp Print Service Plugin.

Simpler to manage

Printing or receiving information directly from your business systems and cloud-based applications is made much simpler with Sharp OSA® (Open System Architecture).

And the Application Centre Portal*³ makes the MFP more adaptable by providing software updates and cloud connector apps that enable agile updating.

*¹ For Android devices. ** For both iOS and Android devices. **³ Available at a later date.

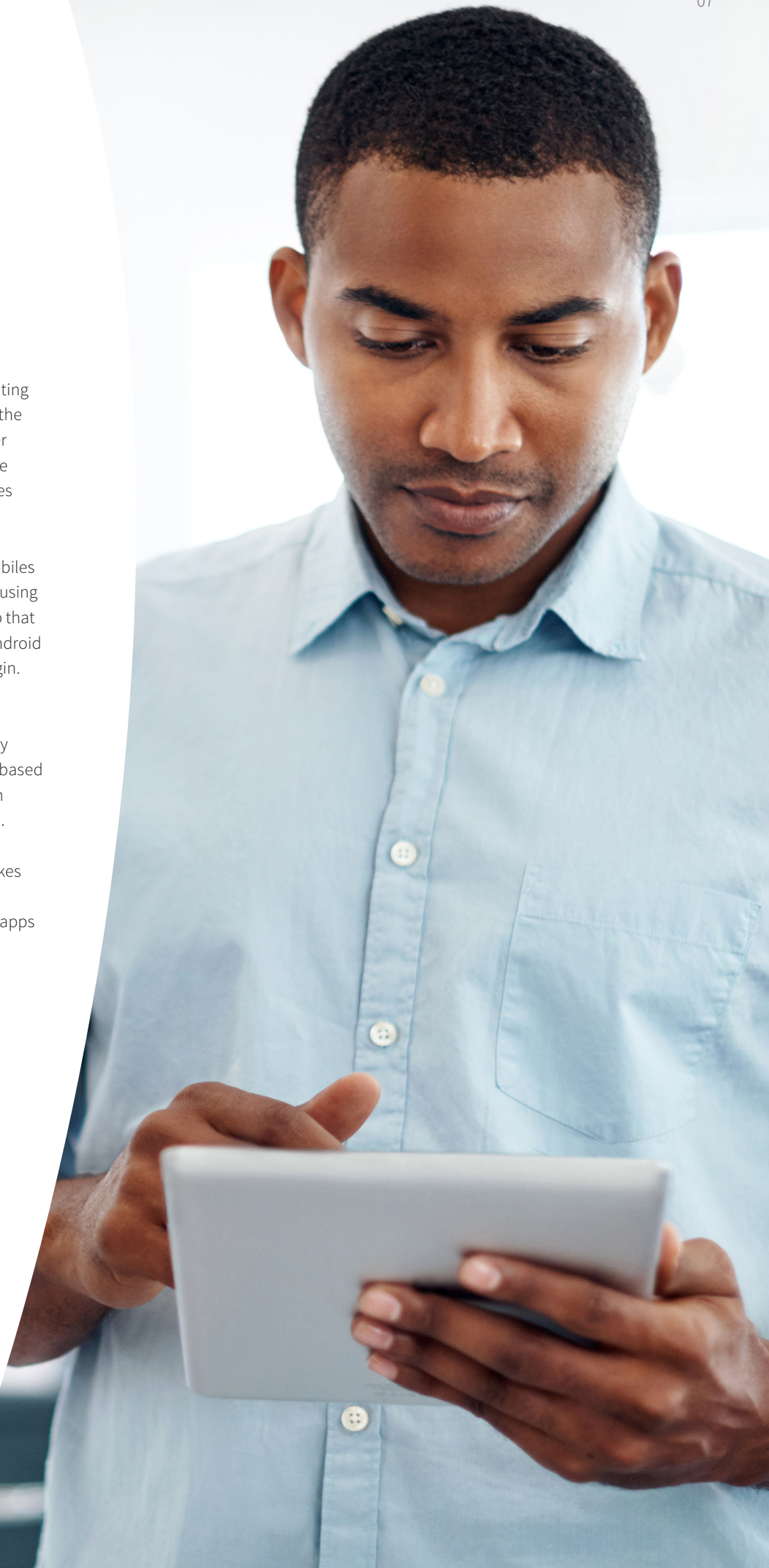

More ways to save.

Our MFPs are designed to help you avoid wasting time and money – without impacting performance.

Even more flexibility

Give your documents a truly professional look with a wide variety of finishing options, including punch, saddle stitching, stapleless stapling and a job separator. Additional capacity paper drawers can also be added to handle the demands of even the busiest office.

Much less energy

As well as producing documents more efficiently, you can also enjoy greater energy efficiency – reducing running costs. Automatic, configurable power settings ensure that the MFP only switches on during set hours. Our low-melt toner reduces the energy consumption on every print or copy run. And the control panel prompts you to choose the most environmentally friendly settings – such as Eco Scan, which prevents unnecessary functions from powering up in the background.



Optimised Software Solutions

We've created a range of Optimised Software Solutions to help you reduce your costs, increase efficiency and improve security.



Optimised Printing Solutions

Monitor and manage your print and copy usage, eliminate unauthorised use, track and recover costs and reduce waste.

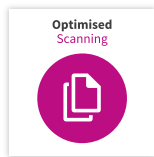

Optimised Scanning Solutions

Save time and avoid costly errors by simplifying and automating how you store and share documents – whatever their format.

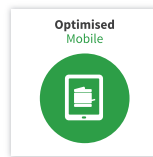

Optimised Mobile Solutions

Create a more flexible team by helping people connect tablets, phones and laptops simply and securely, so they're always in touch.

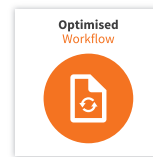

Optimised Workflow Solutions

Help restore the productivity you need to achieve and maintain profitable growth by streamlining and simplifying repetitive tasks.

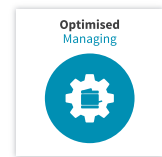

Optimised Managing Solutions

Ease the burden of managing your MFPs and build a consistent Print Security policy.

Smart technology meets forward-thinking connectivity. Helping your teams become more efficient, and more effective.

Configurations

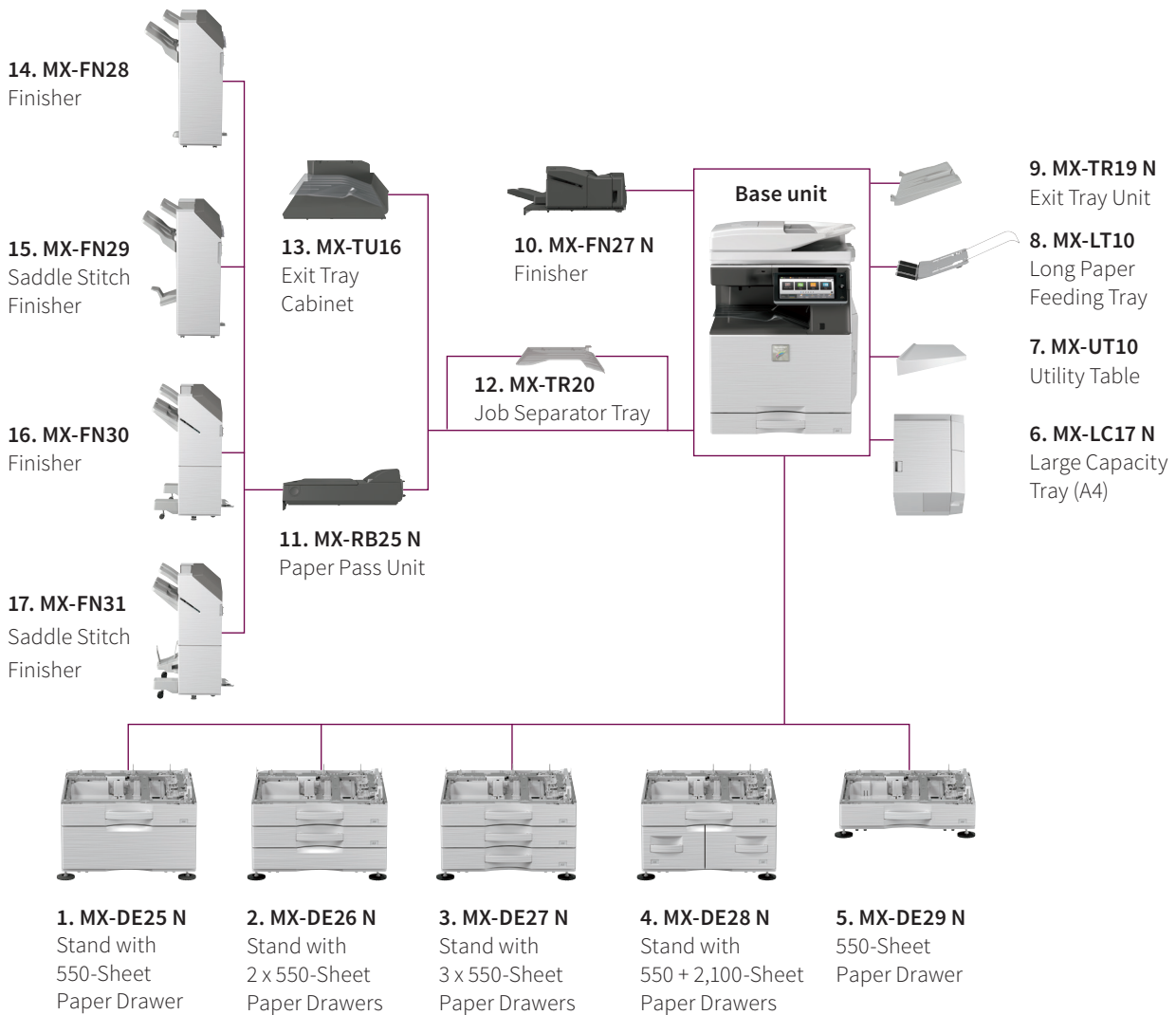

Options

Base unit

- 1. MX-DE25 N Stand with 550-Sheet Paper Drawer**
550 sheets*¹, SRA3 to A5R (60 - 300 g/m²)
- 2. MX-DE26 N Stand with 2 x 550-Sheet Paper Drawer**
550 sheets*¹ each for lower and upper trays, SRA3 to A5R (60 - 300 g/m²)
- 3. MX-DE27 N Stand with 3 x 550-Sheet Paper Drawer**
550 sheets*¹ each for lower and upper trays, SRA3 to A5R (60 - 300 g/m²)
- 4. MX-DE28 N Stand with 550 + 2,100-Sheet Paper Drawer**
Upper tray: SRA3 - A5R, 550 sheets*¹ (60 - 300 g/m²).
Lower tray (Left): A4, 1,200 sheets*¹ (60 - 105 g/m²)
Lower tray (Right): A4 - B5, 900 sheets*¹ (60 - 105 g/m²)
- 5. MX-DE29 N 550-Sheet Paper Drawer**
550 sheets*¹, SRA3 to A5R (60 - 300 g/m²)
- 6. MX-LC17 N Large Capacity Tray (A4)**
3,000 sheets*¹, A4 - B5 (60 - 220 g/m²)
- 7. MX-UT10 Utility Table**

Finishing

- 8. MX-LT10 Long Paper Feeding Tray**
Recommended for banner printing
- 9. MX-TR19 N Exit Tray Unit**
- Optional Punch Module for MX-FN27 N:**
MX-PN14C - 2/4 Hole Punch Module
MX-PN14D - 4 Hole Wide Punch Module
- 10. MX-FN27 N Inner Finisher**
A3 - B5 (offset/staple), SRA3 - A5R (non offset)
Offset tray (upper): max. 500-sheet paper capacity*¹
Stapling capacity: max. 50-sheet multi-position staple*¹
Staple position: 3 locations (front, rear or 2 point stitching)
Manual Stapling: 1-point at rear (Flat), 45 sheets (64 g/m²), 40 sheets (80 g/m²)
Stapleless capacity: max.5-sheet (64 g/m²), 4 sheet (65 - 81.4 g/m²), 3 sheet (81.5 - 105 g/m²)
Stapleless position: 1-point at rear (Slant), A3 - B5

*¹ Number of sheets based on 80 g/m².

Options

11. MX-RB25 N Paper Pass Unit

Required when using MX-FN28, MX-FN29, MX-FN30 & MX-FN31

12. MX-TR20 Job Separator Tray

Requires MX-TU16 Exit Tray Cabinet

13. MX-TU16 Exit Tray Cabinet

Optional Punch Module for MX-FN28 & MX-FN29:

MX-PN15C - 2/4 Hole Punch Module

MX-PN15D - 4 Hole Wide Punch Module

14. MX-FN28 1k Finisher

A3W - A5R (offset/staple), SRA3 - A5R (non offset)

Offset tray (upper): max.1,000-sheet paper capacity*¹

Stapling capacity: max. 50-sheet multi-position staple*¹

Staple position: 1-point at front (Flat), 1-point at back (Flat), 2 point stitching

15. MX-FN29 1k Saddle Stitch Finisher

A3W - A5R (offset/staple), SRA3 - A5R (non offset)

Offset tray (upper): max.1,000-sheet paper capacity*¹

Stapling capacity: max. 50-sheet multi-position staple*¹

Staple position: 1-point at front (Flat), 1-point at back (Flat), 2 point stitching

Saddle stitch tray (lower): 7 sets (11-15 sheets), 10 sets (6-10 sheets),

20 sets (1-5 sheets). 15 sheets max per set

Optional Punch Module for MX-FN30 & MX-FN31:

MX-PN16C - 2/4 Hole Punch Module

MX-PN16D - 4 Hole Wide Punch Module

16. MX-FN30 3k Finisher

A3 - B5 (offset/staple), SRA3 - A5R (non offset)

Offset tray (upper): max.3,000-sheet paper capacity*¹

Stapling capacity: max. 65-sheet multi-position staple*¹

Staple position: 1-point at front (Slant), 1-point at back (Slant), 2 point stitching

Manual Stapling: 1-point at rear (Flat), 45 sheets (64 g/m²), 40 sheets (80 g/m²)

Stapleless capacity: max.5-sheet (64 g/m²), 4 sheet (65 - 81.4 g/m²),

3 sheet (81.5 - 105 g/m²)

Stapleless position: 1-point at rear (Slant), A3 - B5

17. MX-FN31 3k Saddle Stitch Finisher

A3 - B5 (offset/staple), SRA3 - A5R (non offset)

Offset tray (upper): max.3,000-sheet paper capacity*¹

Stapling capacity: max. 65-sheet multi-position staple*¹

Staple position: 1-point at front (Slant), 1-point at back (Slant), 2 point stitching

Manual Stapling: 1-point at rear (Flat), 45 sheets (64 g/m²), 40 sheets (80 g/m²)

Stapleless capacity: max.5-sheet (64 g/m²), 4 sheet (65 - 81.4 g/m²),

3 sheet (81.5 - 105 g/m²)

Stapleless position: 1-point at rear (Slant), A3 - B5

Saddle stitch tray (lower): 10 sets (11-15 sheets), 15 sets (6-10 sheets),

25 sets (1-5 sheets). 20 sheets max per set

Printing

MX-PF10 Barcode Font Kit

Enables barcode printing

Faxing

MX-FX15 Fax Expansion Kit

MX-FWX1 Internet Fax Expansion Kit

Scanning

AR-SU1 Stamp Unit

Marks already scanned documents for checking

Sharpdesk Licenses

MX-USX1/X5

1/5-License Kit

MX-US10/50/A0

10/50/100-License Kit

Sharp OSA®

MX-AMX1 Application Integration Module

Security

MX-FR62U Data Security Kit

Commercial Version

Model shown MX-4071

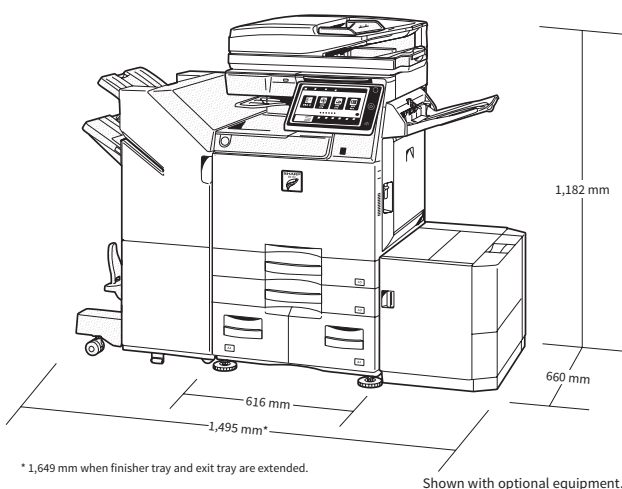

Model shown MX-4061

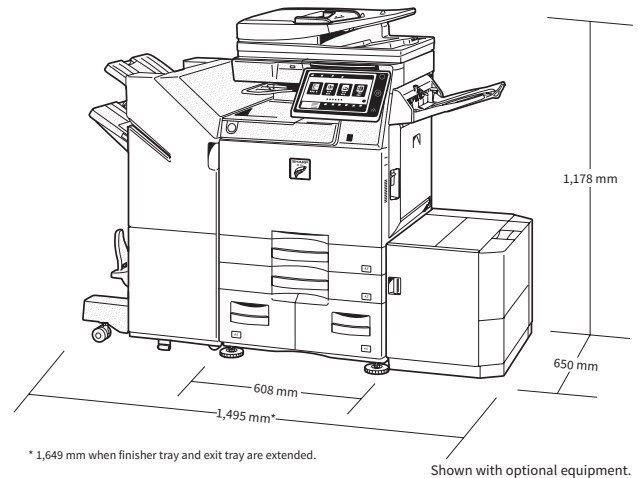

*¹ Number of sheets based on 80 g/m².

Specifications

General

Engine speed (ppm/cpm) (Max)	A4*	A3	SRA3
MX-4071/MX-4061	40	20	18
MX-3571/MX-3561	35	18	16
MX-3071/MX-3061	30	16	15
Control panel display	10.1-inch colour LCD touchscreen		
Paper size (Min – Max)	A5*2 - SRA3		
Paper weight (g/m ²)			
Tray	60 - 300		
Multi-bypass	55 - 300		
Paper capacity (Std – Max)			
Sheets	650 - 6,300		
Drawers	1 - 4 (plus bypass tray)		
Warm-up time *3 (seconds)	20**		
Memory (GB)			
Copier/Printer (shared)	5		
HDD**5	500		
Power requirements	Rated local AC voltage ±10%, 50/60 Hz		
Power consumption (kW) (Max)	1.84 (220 to 240V)		
Dimensions *6 (mm) (W x D x H)			
MX-4071/MX-3571/MX-3071	616 x 660 x 838		
MX-4061/MX-3561/MX-3061	608 x 650 x 834		
Weight (kg)			
MX-4071/MX-3571/MX-3071	88		
MX-4061/MX-3561/MX-3061	79		

Copier

Original paper size (Max)	A3	
First copy time *7 (seconds)	Full colour	B/W
	6.7	4.7
Continuous copies (Max)	9,999	
Print resolution (dpi)		
Scan (colour)	600 x 600	
Scan (B/W)	600 x 600, 600 x 400	
Print	1,200 x 1,200, 600 x 600, 9,600 (equivalent) x 600 (depending on copy mode)	
Gradation levels	256	
Zoom range (%)	25 – 400, (25 – 200 using DSPF/RSPF) in 1% increments	
Presets copy ratios (Metric)	10 ratios (5R/5E)	

Wireless LAN

Compliant regulation	IEEE802.11n/g/b
Access mode	Infrastructure mode, Software AP mode
Security	WEP, WPA/WPA2-mixed PSK, WPA/WPA2-mixed EAP**8, WPA2 PSK, WPA2 EAP**8

Network Scanner

Scan method	Push scan (via control panel) Pull scan (TWAIN-compliant application)	
Scan speed *9 (ipm) (Max)	One-sided	Two-sided
MX-4071/MX-3571/MX-3071	110	220
MX-4061/MX-3561/MX-3061	80	25
Resolution (dpi) (Max)		
Push scan	100, 150, 200, 300, 400, 600	
Pull scan	75, 100, 150, 200, 300, 400, 600 50 to 9,600 dpi via user setting	
File formats	TIFF, PDF, PDF/A-1a, PDF/A-1b, encrypted PDF, compact PDF**10, JPEG**10, XPS, searchable PDF, Microsoft® Office (pptx, xlsx, docx), text (TXT), rich text (RTF)	
Scan destinations	Scan to e-mail, desktop, FTP server, network folder (SMB), USB memory, HDD, URL	
Scanner utilities	Sharpdesk	

Document Filing

Document filing capacity **11	Pages	Files
Main & custom folders	20,000	3,000
Quick file folder	10,000	1,000
Stored jobs **12	Copy, print, scan, fax transmission	
Storage folders	Quick file folder, main folder, custom folder (max. 1,000)	
Confidential storage	Password protection (for main & custom folders)	

Network Printer

Resolution (dpi)	1,200 x 1,200, 600 x 600, 9,600 (equivalent) x 600
Interface	USB 2.0, 10Base-T/100Base-TX/1000Base-T, Optional secondary LAN support
Supported OS	Windows Server® 2008, 2008R2, 2012, 2012R2, 2016, Windows® 7, 8.1, 10 Mac OS X 10.6, 10.7, 10.8, 10.9, 10.10, 10.11, 10.12, 10.13
Network protocols	TCP/IP (IPv4, IPv6)
Printing protocols	LPR, Raw TCP (port 9100), POP3 (e-mail printing), HTTP, FTP for downloading print files, IPP, SMB, WSD
PDL	PCL 6 emulation, Adobe® PostScript®3™
Available fonts	80 fonts for PCL, 139 fonts for Adobe PostScript 3

Fax (optional MX-FX15 required)

Compression method	MH/MR/MMR/JBIG
Communication protocol	Super G3/G3
Transmission time **13 (seconds)	Less than 2
Modem speed (bps)	33,600 – 2,400 with automatic fallback
Transmission resolution (dpi)	203.2 x 97.8 (Std) / 406.4 x 391 (Ultra Fine)
Recording width	A3 – A5
Memory (GB)	1 (built-in)

*1 Long-edge feeding. *2 Only short-edge feeding can be used with A5 paper. *3 At rated voltage, 23°C (73.4°F). May vary depending on operating conditions and environment. **4 When starting the MFP via the power button. 33 seconds when starting the MFP via the main power switch. **5 HDD capacity depends on procurement and sourcing status. **6 Including adjusters and protuberances. **7 Long-edge feeding of A4 sheets from 1st paper tray, using document glass, without Auto Colour Selection and Auto Colour mode, MFP in fully ready condition. May vary depending on operating conditions and environment. **8 Not applicable to Software AP mode. **9 Based on Sharp's A4 standard chart, using document feeder and long-edge feeding. Using factory default settings with Auto Colour Selection off. Scan speed will vary depending on the type of document and the scan settings. **10 Colour/greyscale only. **11 Storage capacity will vary depending on the type of document and the scan settings. **12 Some features require option(s). **13 Based on Sharp's standard chart with approx. 700 characters (A4 long-edge feeding) at standard resolution in Super G3 mode, 33,600 bps, JBIG compression.

Design and specifications are subject to change without prior notice. All information was correct at time of print. Microsoft, Excel, PowerPoint, OneDrive, SharePoint, Active Directory, Windows Server, and Windows are either registered trademarks or trademarks of Microsoft Corporation in the US and/or other countries. Adobe and PostScript 3 are either registered trademarks or trademarks of Adobe Systems Incorporated in the US and/or other countries. Google Drive, Gmail, Android, and Google Cloud Print are trademarks of Google LLC. The Google Drive trademark is used with permission from Google LLC. Box is a trademark, service mark, or registered trademark of Box, Inc. QR Code is a registered trademark of DENSO WAVE INCORPORATED in Japan and other countries. AirPrint and Mac are trademarks of Apple Inc., registered in the US and other countries. PCL is a registered trademark of Hewlett-Packard Company. Qualcomm DirectOffice is a product of Qualcomm Technologies, Inc. and/or its subsidiaries. Qualcomm is a trademark of Qualcomm Incorporated, registered in the US and other countries. DirectOffice is a trademark of CSR Imaging US, LP, registered in the US and other countries. All other company names, product names and logos are trademarks or registered trademarks of their respective owners. ©Sharp Corporation December 2018. Ref: MX-4071/MX-3571/MX-3071/MX-4061/MX-3561/MX-3061. Brochure (Job 19421). All trademarks acknowledged. E&O.